

lungomare

design Archirivolto

LUNGOMARE design Archirivolto

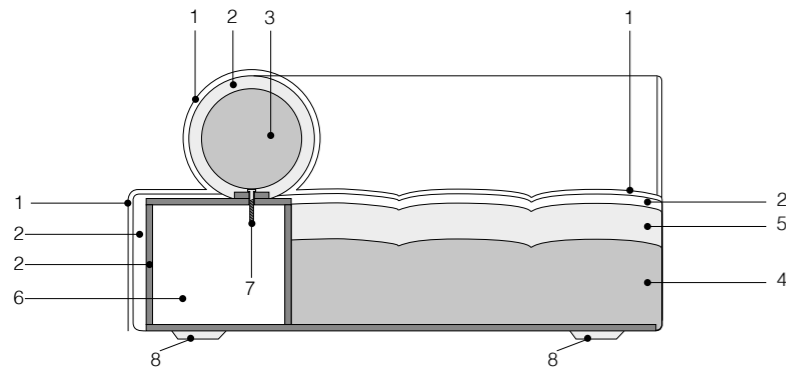

- DIVANO -

LEGENDA

- 1- Rivestimento in PVC impermeabile antistatico, antibatterico, antiacaro
- 2- Falda R&R gr. 400
- 3- Poliuretano Espanso PF 25 SM
- 4- Poliuretano Espanso T 25 CME
- 5- Poliuretano Espanso elast PF 35 FR
- 6- Multistrato marino
- 7- Sistema di bloccaggio PVC/acciaio
- 8- Piede in PVC con antiscivolo

LEGEND

- 1- Waterproof PVC coating antistatic, antibacterial, antimite
- 2- Padding R&R gr. 400
- 3- Polyurethane foam PF 25 SM
- 4- Polyurethane foam T 25 CME
- 5- Polyurethane foam elast PF 35 FR
- 6- Marine plywood
- 7- PVC/steel locking system
- 8- PVC foot with non-slip

LEGENDE

- 1- Revêtement PVC imperméable antistatique, antibactérien, antiacarien
- 2- Rembourrage R&R gr. 400
- 3- Mousse de polyuréthane PF 25 SM
- 4- Mousse de polyuréthane T 25 CME
- 5- Mousse de polyuréthane elast PF 35 FR
- 6- Multicouche marin
- 7- Système de verrouillage PVC/acier
- 8- Pied en PVC avec antidérapant

ERLÄUTERUNGEN

- 1- Wasserdichte PVC-Beschichtung antistatisch, antibakteriell, antimilben
- 2- Polsterung Tecnoform R&R gr. 400
- 3- Polyurethanschaum PF 25 SM
- 4- Polyurethanschaum T 25 CME
- 5- Polyurethanschaum elast PF 35 FR
- 6- Bootsbausperrholz
- 7- Verschlussystem aus PVC/Stahl
- 8- PVC-Fuß mit rutschfestem

Struttura interna:
in multistrato marino.
Seduta e schienale:
in poliuretano espanso a quote differenziate e falda termolegata.
Cuscini volanti:
rollofill H.53 rivestito in PVC impermeabile.
Rivestimento:
tessuto.
Svestibilità:
totale.
Nota:
per le composizioni si prega di completare l'ordine con un disegno in pianta degli elementi scelti.

Internal frame:
in marine multi-ply.
Seat and backrest:
in multi-density polyurethane foam with heat-bonded padding.
Loose cushions:
rollofill H.53 covered in waterproof PVC.
Cover:
fabric.
Covers:
fully removable covers.
Upholstery:
fabric or leather.
Note:
for modular layout, please attach a schematic drawing of the chosen elements to your order.

Structure interne:
en multicouche marin.
Assise et dossier:
en mousse de polyuréthane à cotes différenciées et rembourrage lié thermiquement.
Coussins volants:
rollofill H.53 recouvert de PVC imperméable.
Revêtement:
tissu.
Déhoussabilité:
totale.
Note:
pour les compositions, veuillez compléter la commande par un dessin en plan des éléments choisis.

Innenkorpus:
aus Bootsbausperrholz.
Sitz und Rückenlehne:
aus Polyurethanschaum unterschiedlicher Dichte und wärmegebundener Polsterung.
Loose Kissen:
rollofill H.53 mit wasserdichtem PVC überzogen.
Trapezpolsterelemente:
formschaum und vernickelten Kugeln.
Bezug:
aus Stoff.
Abziehbarkeit:
komplett.
Anmerkung:
Für die Kombinationen fügen Sie bitte dem Auftrag eine Planzeichnung der von Ihnen ausgewählten Elemente bei.

Pouf. Pouf

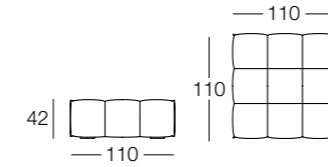

Centrale sx-dx . LH-RH central unit

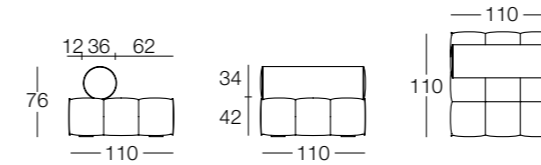

Terminale sx-dx . LH-RH end piece

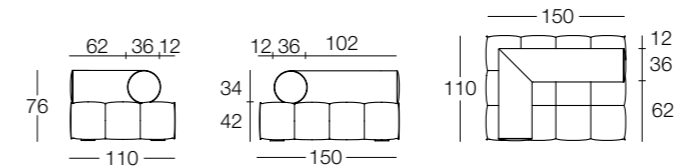

Terminale con bracciolo inclinato sx-dx . LH-RH end piece with inclined armrest

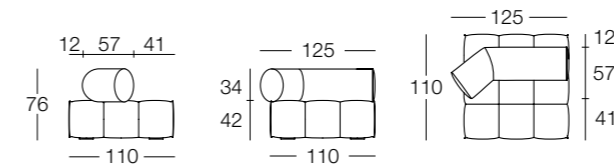

Cuscini volanti . Loose cushions

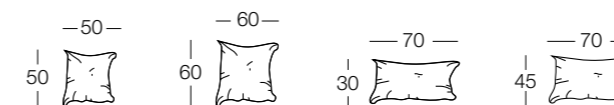

Struttura in multistrato marino, imbottitura in poliuretano espanso a quote differenziate, falda termolegata e rivestiti in pvc impermeabile antistatico, antibatterico e antiacaro. Cuscini volanti in Rollofill rivestito in PVC impermeabile e traspirante. Svestibilità totale.

Frame in marine multi-ply, padded in multi-density polyurethane foam with heat-bonded padding and upholstered in waterproof PVC coating antistatic, antibacterial, antimite. Loose cushions in Rollofill covered in waterproof PVC. Fully removable covers.

Composizioni . Compositions

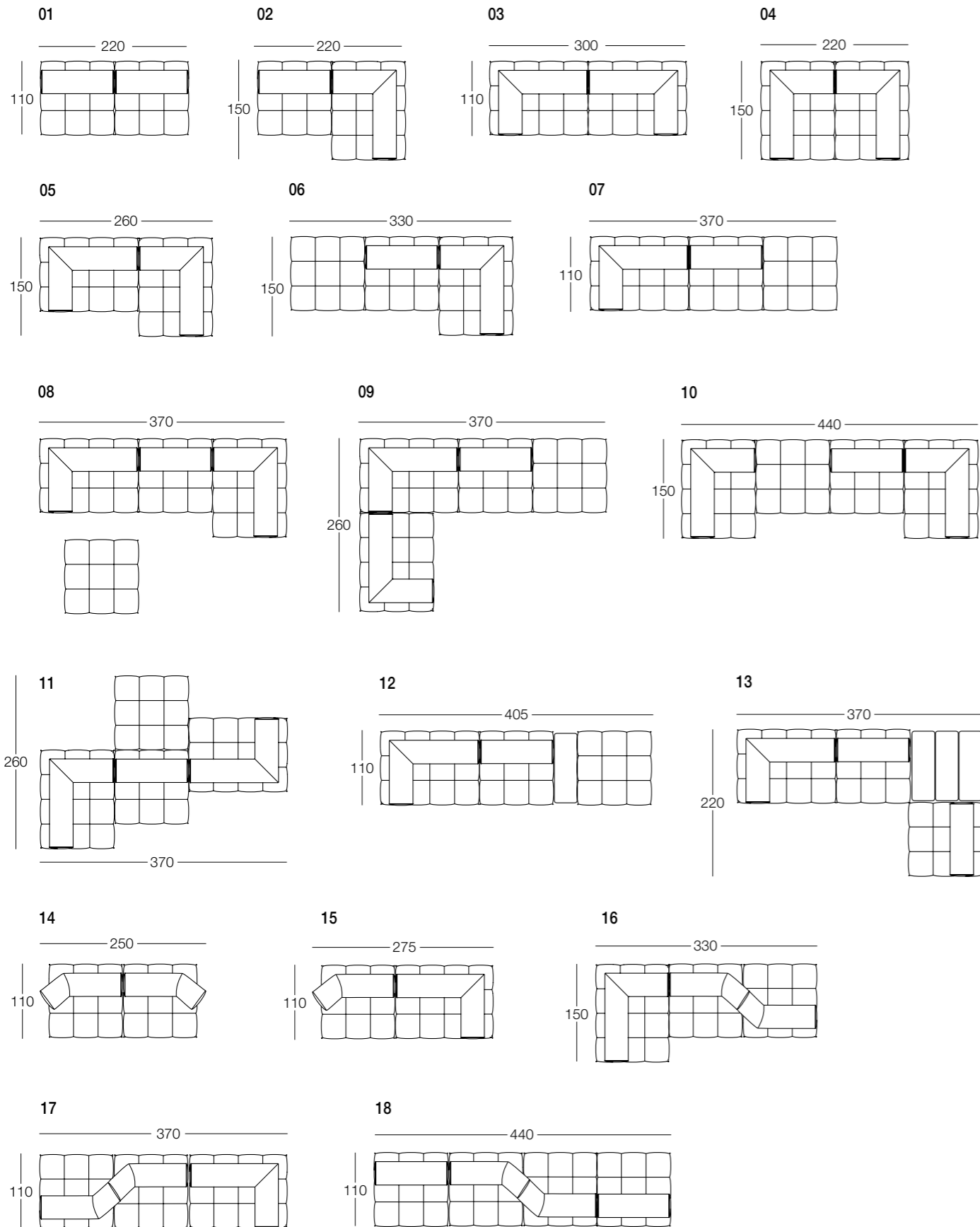

Lungomare tavolini . Coffee tables

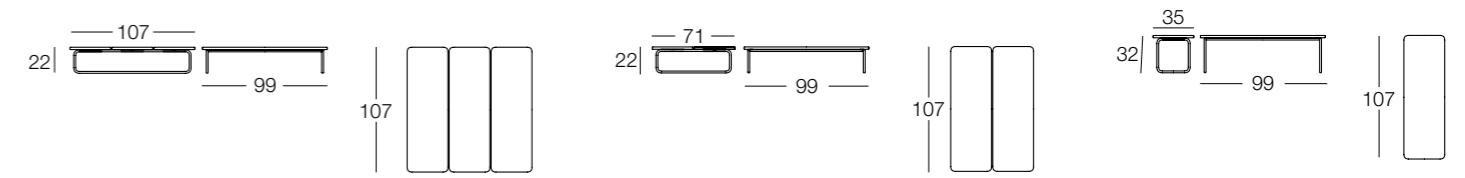

Struttura in metallo verniciato nero semiopaco (RAL 9005). Piano in legno Iroko finitura ad olio.

Frame in semi-opaque black painted metal (RAL 9005). Top: in Iroko wood with oil finish.

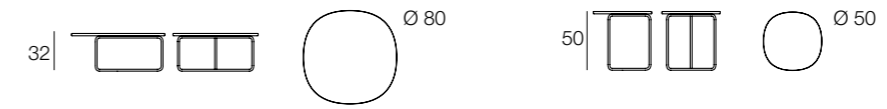

Struttura in metallo verniciato nero semiopaco (RAL 9005). Piano in travertino con trattamento idrorepellente.

Frame in semi-opaque black painted metal (RAL 9005). Top: in travertine with water-repellent treatment.